

Octagonal Pergola Datasheet

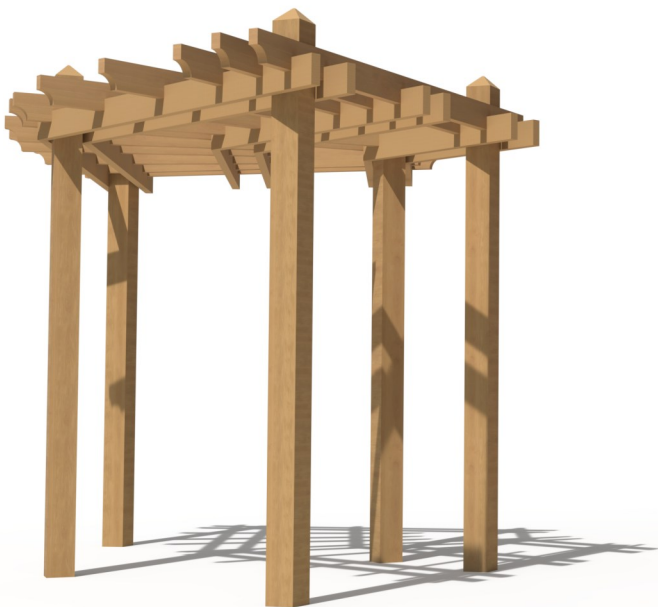

Octagonal Pergola

Pergola made from timber and galvanised steel feet

4819mm (L) x 2800mm (W) x 2858mm (H)

Material:
Galvanised mild steel base plates and bolts.

Timber:
Wooden seat element of this product can be either of the timbers below. With the option for these to be PEFC / FSC certified. All timber supplied planed all round with 4mm radius to all edges. A2 Stainless steel screws.

Installation:
For the products installation, there are holes in the base for anchoring embedment bolts into concrete foundations laid by others. Insert 12mm threaded bolts into holes drilled into the concrete slabs and fill with epoxy resin or fast motor.

*Below are powder coating options for the galvanised metalwork only.

Maintenance:
Manufactured from galvanised mild steel to BS EN ISO 1461:1999 - rinse thoroughly once every six months with a salt free wash and wax solution and polish with a soft clean cloth.

Timber - Manufactured entirely from carefully selected and graded hardwood / softwood. Sourced entirely from commercially managed, recognised and sustainable resources with a natural un-treated finish, to remove stains sand lightly with an appropriate grade sandpaper.

Check fixing connections every six months to ensure they are secure and tighten as required.

The wooden seat can be replaced if necessary.

Standard Colours

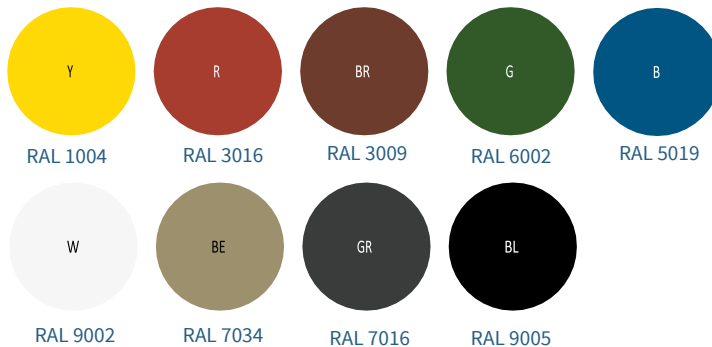

Pastel Colours

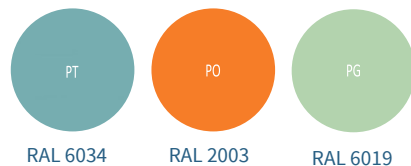

Standard Timber



Octagonal Pergola

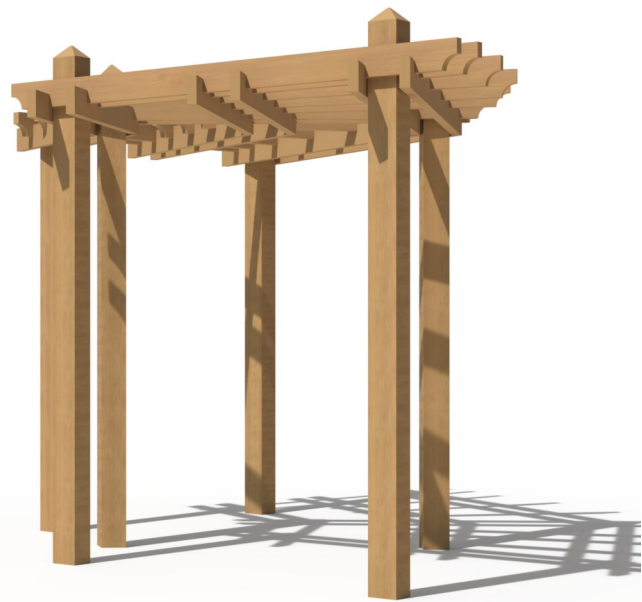
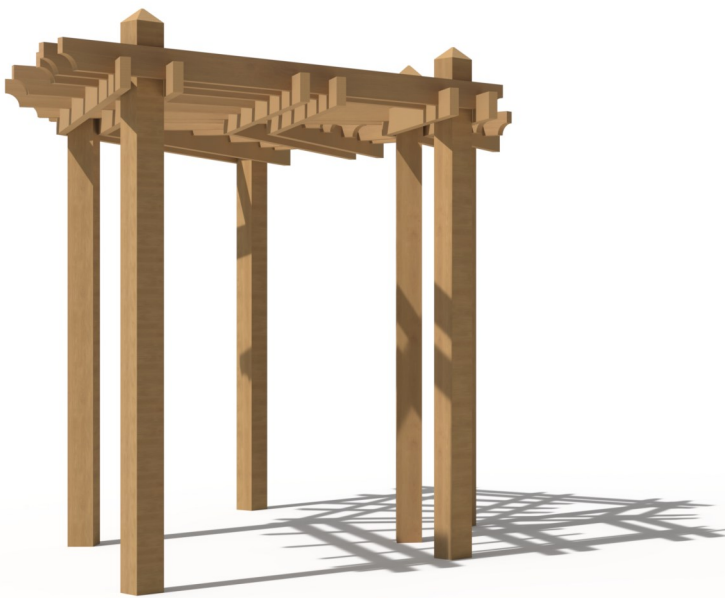
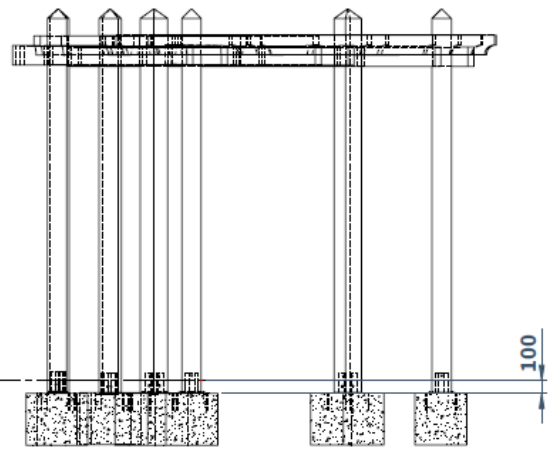
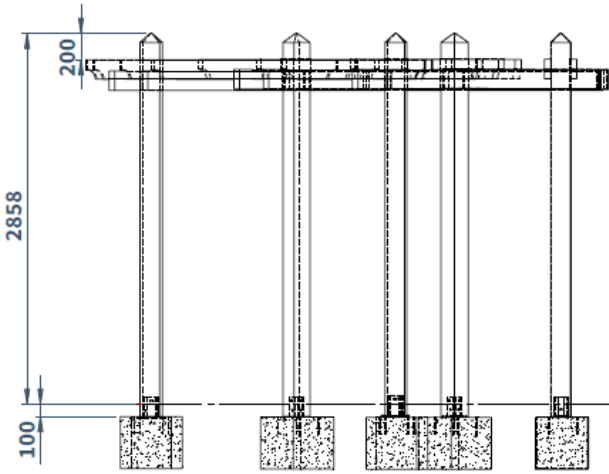
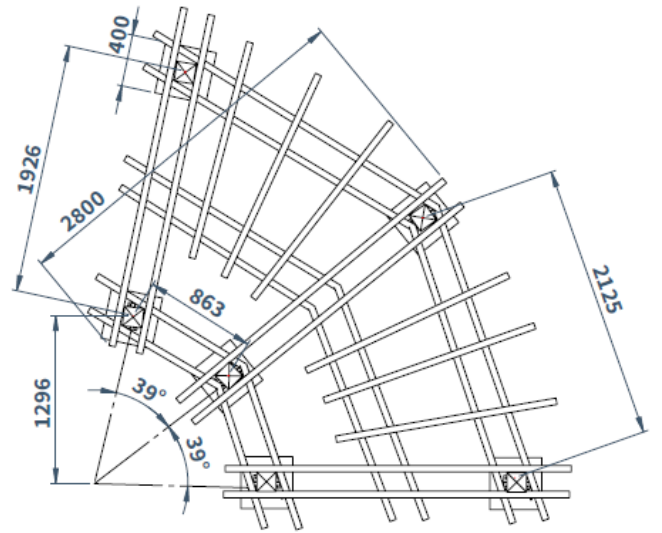

Octagonal Pergola



 Landmark
STREET FURNITURE

www.landmarkstreetfurniture.com